

Advantage 2000+ Workstations



FEATURES

- Workstation widths of 26", 50" and 72"
- Symmetrical, welded steel framework
- Integrated enclosures
- Laminated work surfaces
- Tapped holes, one screw size
- One tool for assembly
- Vertical adjustability in 1" increments
- Front access to cable management
- Shelf weight capacities up to 775 lbs.

Advantage 2000 Plus workstations utilize open frame architecture with symmetrical, welded steel framework to provide effective technical workspace management. This framework, coupled with a modular design concept, permits maximum flexibility in workspace configuration, as well as the capability to provide secure and enclosed environments.

Additionally, Advantage 2000 Plus allows a completely customized workspace with a full compliment of user-specific, accessory solutions such as storage compartments, task lights and keyboard trays.

BENEFITS

- Flexible, customized workspace configurations
- Easy to assemble and re-configure
- Secures and protects equipment
- Adapts easily to changing workspace requirements
- Durable construction - built for longevity
- Easy to configure and order
- Quick delivery

**Available on GSA Schedule
Contract No: GS-28F-0039N**

Advantage 2000+ Workstations

GL2050-A1



2550-SC
Lockable overhead storage compartment, weight capacity 200 lbs.

2350
Brace and cover

2450-HCM
Front access horizontal cable management tray

2250
Four point solid shelf, weight capacity 600 lbs.

2250-CT
Laminated countertop extension, weight capacity 300 lbs.

2350
Brace and cover

2250
Four point solid shelf, weight capacity 600 lbs.

GL2072-A1

Dimensions: 76.00"W x 45.20"D x 78.00-79.50"H*

Part No.	Qty.	Description
2001-DF	2	"d" frame upright
2272	2	Four point solid shelf (71.75"W x 25.50"D)
2272-CT	1	Laminated countertop extension (74"W x 16"D)
2372	2	Brace and cover
2472-HCM	1	Front access horizontal cable management tray
2400-VCM	3	Vertical cable management (qty. 2 makes one run below storage comp.)
2572-SC	1	Lockable storage compartment
7215	1	16 position power strip w/ circuit breaker, 5-15P plug, 49" long
2540-PSB	1	Vertical power strip mounting bracket, one set
<i>Approximate shipping weight 590 lbs.</i>		

GL2050-A1

Dimensions: 54.00"W x 45.20"D x 78.00-79.50"H*

Part No.	Qty.	Description
2001-DF	2	"d" frame upright
2250	2	Four point solid shelf (49.75"W x 25.50"D)
2250-CT	1	Laminated countertop extension (52"W x 16"D)
2350	2	Brace and cover
2450-HCM	1	Front access horizontal cable management tray
2400-VCM	3	Vertical cable management (qty. 2 makes one run below storage comp.)
2550-SC	1	Lockable storage compartment
7215	1	16 position power strip w/ circuit breaker, 5-15P plug, 49" long
2540-PSB	1	Vertical power strip mounting bracket, one set
<i>Approximate shipping weight 460 lbs.</i>		

NOTE: To configure a 26" workstation, please refer to the accessory pages 73-76.

68 * Height with standard leveling glides. Height with optional casters is 80.75".

Advantage 2000+ Workstations

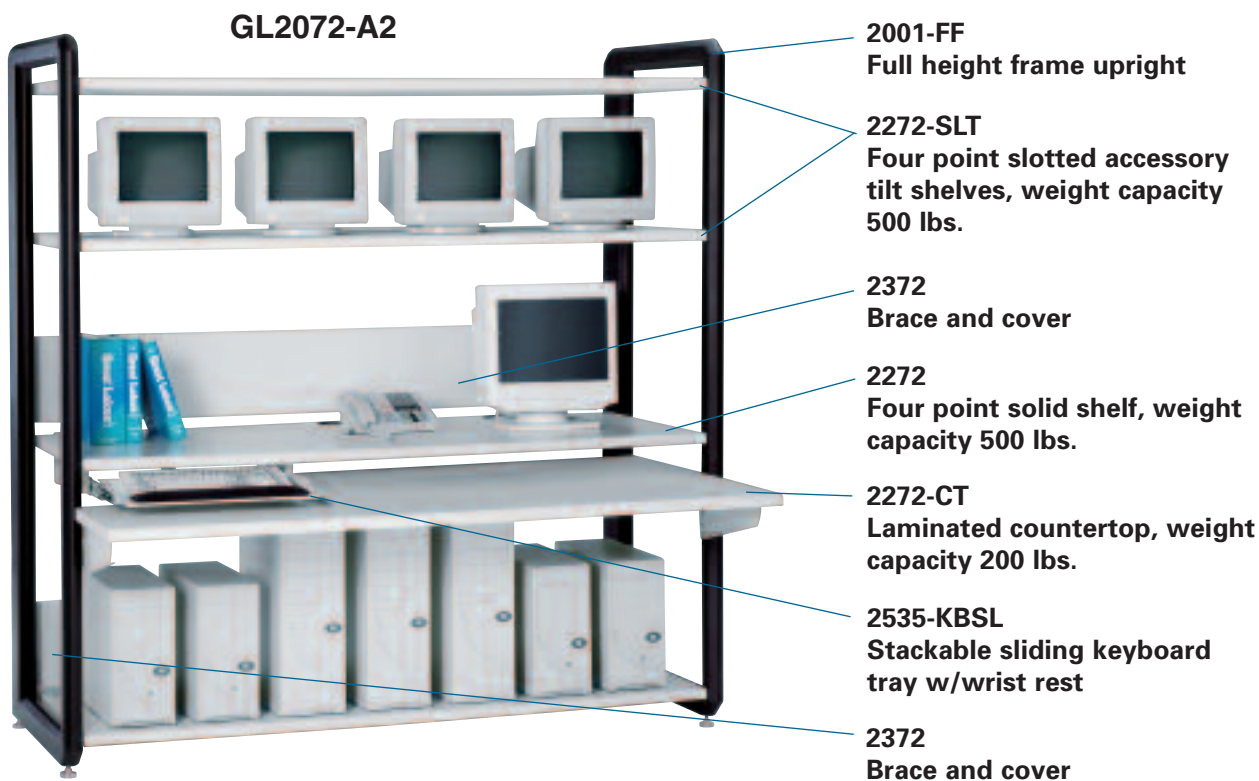

GL2072-A2

Dimensions: 76.00"W x 45.20"D x 78.00-79.50"H*

Part No.	Qty.	Description
2001-FF	2	Full height frame upright
2272	2	Four point solid shelf (71.75"W x 25.50"D)
2272-SLT	2	Four point slotted accessory tilt shelf (71.75"W x 25.50"D)
2272-CT	1	Laminated countertop extension (74"W x 16"D)
2372	2	Brace and cover
2472-HCM	2	Front access horizontal cable management tray
2400-VCM	3	Vertical cable management (qty. 3 makes one run)
2535-KBSL	1	Stackable sliding keyboard tray w/wrist rest
2540-AS	6	Anti-slide bracket
7215	1	16 position power strip w/ circuit breaker, 5-15P plug, 49" long
2540-PSB	1	Vertical power strip mounting bracket, one set

Approximate shipping weight 620 lbs.

GL2050-A2

Dimensions: 54.00"W x 45.20"D x 78.00-79.50"H*

Part No.	Qty.	Description
2001-FF	2	Full height frame upright
2250	2	Four point solid shelf (49.75"W x 25.50"D)
2250-SLT	2	Four point slotted accessory tilt shelf (49.75"W x 25.50"D)
2250-CT	1	Laminated countertop extension (52"W x 16"D)
2350	2	Brace and cover
2450-HCM	1	Front access horizontal cable management tray
2400-VCM	3	Vertical cable management (qty. 3 makes one run)
2535-KBSL	1	Stackable sliding keyboard tray w/wrist rest
2540-AS	4	Anti-slide bracket
7215	1	16 position power strip w/ circuit breaker, 5-15P plug, 49" long
2540-PSB	1	Vertical power strip mounting bracket, one set

Approximate shipping weight 495 lbs.

NOTE: To configure a 26" workstation, please refer to the accessory pages 73-76.

* Height with standard leveling glides. Height with optional casters is 80.75".

Advantage 2000+ Workstations



GL2072-A3

- 2001-FF Full frame upright
- 2272-SLT Four point slotted tilt shelves, weight capacity 500 lbs.
- 2372 Brace and cover
- 2472-HCM Front access horizontal cable management tray
- 2272-DLA Laminated work surface reinforced with steel accessory mounting underplate
- 2535-KBSL Stackable sliding keyboard tray w/wrist rest
- 2372 Brace and cover
- 2272 Four point solid shelf, weight capacity 500 lbs.

GL2072-A3

Dimensions: 76.00"W x 35.20"D x 78.00-79.50"H*

Part No.	Qty.	Description
2001-FF	2	Full frame upright
2272-DLA	1	Laminate work surface (71.75"W x 31.56"D) reinforced with steel accessory mounting underplate
2272	1	Four point solid shelf (71.75"W x 25.50"D)
2272-SLT	2	Four point slotted accessory tilt shelf (71.75"W x 25.50"D)
2472-HCM	1	Front access horizontal cable management tray
2400-VCM	3	Vertical cable management (qty. 3 makes one run)
2372	2	Brace and cover
2535-KBSL	1	Stackable sliding keyboard tray w/wrist rest
2540-AS	6	Anti-slide bracket
7215	1	16 position power strip w/ circuit breaker, 5-15P plug, 49" long
2540-PSB	1	Vertical power strip mounting bracket, one set

Approximate shipping weight 595 lbs.

GL2050-A3

Dimensions: 54.00"W x 35.20"D x 78.00-79.50"H*

Part No.	Qty.	Description
2001-FF	2	Full frame upright
2250-DLA	1	Laminate work surface (49.75"W x 31.56"D) reinforced with steel accessory mounting underplate
2250	1	Four point solid shelf (49.75"W x 25.50"D)
2250-SLT	2	Four point slotted accessory tilt shelf (49.75"W x 25.50"D)
2450-HCM	1	Front access horizontal cable management tray
2400-VCM	3	Vertical cable management (qty. 3 makes one run)
2350	2	Brace and cover
2535-KBSL	1	Stackable sliding keyboard tray w/wrist rest
2540-AS	6	Anti-slide bracket
7215	1	16 position power strip w/ circuit breaker, 5-15P plug, 49" long
2540-PSB	1	Vertical power strip mounting bracket, one set

Approximate shipping weight 595 lbs.

Advantage 2000+ Workstations

GL2072-A4

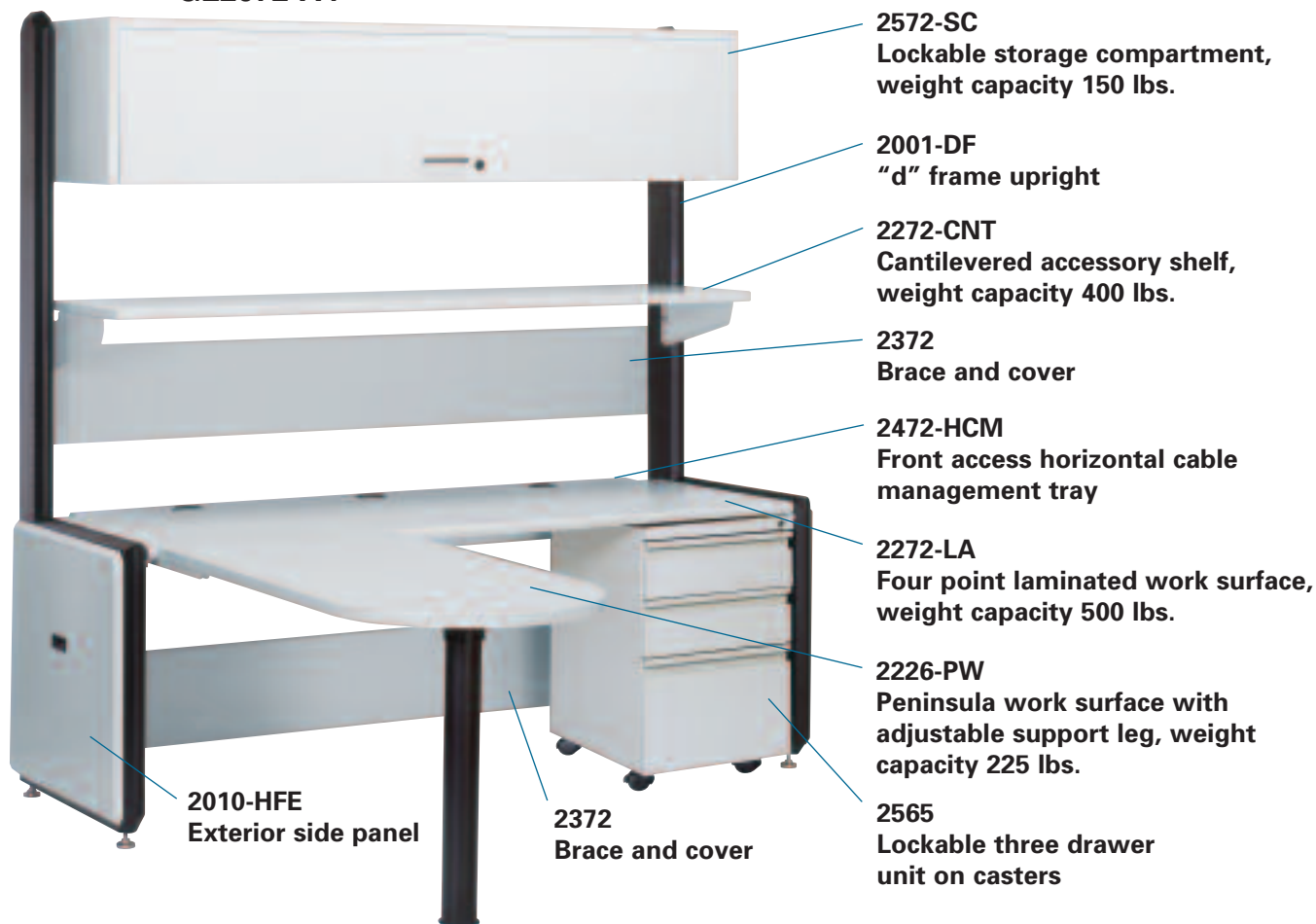

GL2072-A4

Dimensions: 77.50"W x 77.20"D x 78.00-79.50"H*

Part No.	Qty.	Description
2001-DF	2	"d" frame upright
2010-HFE	2	Exterior side panel
2272-LA	1	Four point laminated work surface (71.75"W x 25.50"D)
2272-CNT	1	Cantilevered accessory shelf (71.875"W x 18.00"D)
2572-SC	1	Lockable storage compartment
2226-PW	1	Peninsula work surface with adjustable support leg (24.63"W x 48.00"L)
2535-PD	1	Pencil drawer (20.75"W x 15.00"D)
2565	1	Lockable three drawer unit on casters
2472-HCM	1	Front access horizontal cable management tray
2400-VCM	2	Vertical cable management (qty. 2 makes one run below storage comp.)
2372	2	Brace and cover
7215	1	16 position power strip w/ circuit breaker, 5-15P plug, 49" long
2540-PSB	1	Vertical power strip mounting bracket, one set

Approximate shipping weight 725 lbs.

* Height with standard leveling glides. Height with optional casters is 80.75".

Advantage 2000+ Workstations

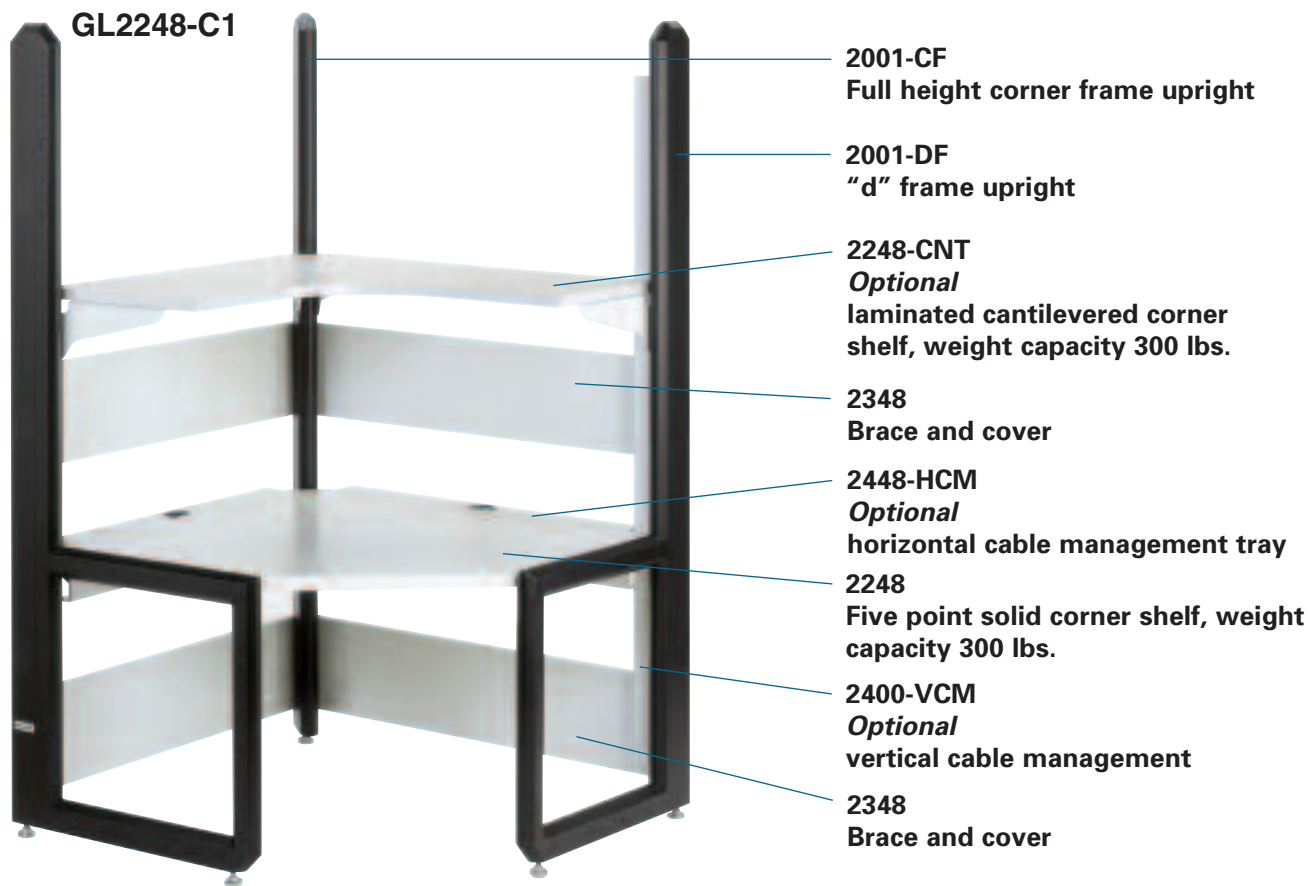

GL2248-C1

Dimensions: 48.00" SQ.

Part No.	Qty.	Description
2001-DF	2	"d" frame upright
2001-CF	1	Full height corner frame upright
2248-CNT	1	Laminated cantilevered corner shelf
2348	4	Brace and cover
2248	1	Five point solid corner shelf <i>Approximate shipping weight 295 lbs.</i>

GL2248-C2

Dimensions: 48.00" SQ.

Part No.	Qty.	Description
2001-FF	2	Full height frame upright
2001-CF	1	Full height corner frame upright
2248-CNT	1	Laminated cantilevered corner shelf
2348	4	Brace and cover
2248	1	Five point solid corner shelf <i>Approximate shipping weight 360 lbs.</i>

Optional Features

Part No.	Description
2248-LA	Five point laminated corner shelf
2248-CT	Laminated countertop extension
2535-KBSL	Stackable sliding keyboard shelf w/wrist rest
2400-VCM	VCM for full frame or "d" frame upright
2448-HCM	Horizontal cable management tray

Advantage 2000+ Workstations

Frame Uprights

- FEATURES:**
- Unique welded steel frame
 - Adjustable in 1" increments
 - Weight capacity 1000 lbs./frame
 - Nylon leveling glides standard
 - Optional casters available

- NOTES:**
- A minimum of two (2) back braces are required to support two frame uprights.
 - Vertical cable runs inside frame uprights are not recommended.

2001-HF

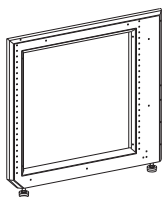

2001-DF

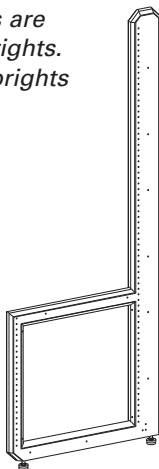

2001-FF

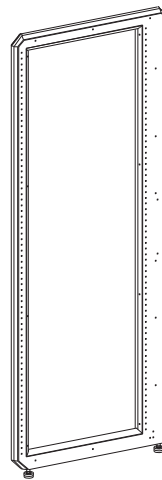

2001-CF



PART NO.	DESCRIPTION	APPROX. WEIGHT
2001-HF	Half height frame upright (30.00"D x 27.125"H)	27 lbs.
2001-DF	"d" frame upright (30.00"D x 77.00"H)	45 lbs.
2001-FF	Full height frame upright (30.00"D x 77.00"H)	56 lbs.
2001-CF	Full height corner frame upright	27 lbs.

Side Panels

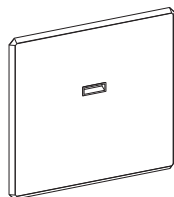

2010-HFE

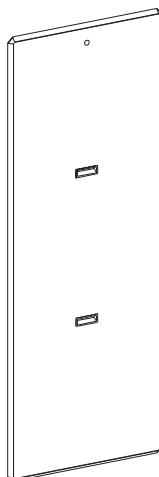

2010-FFEL

PART NO.	DESCRIPTION	APPROX. WEIGHT
2010-HFE	Exterior side panel for half height frame upright	12 lbs.
2010-FFEL	Exterior side panel for full height frame upright w/lock	28 lbs.

Braces

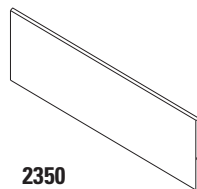

2350

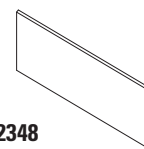

2348

PART NO.	DESCRIPTION	APPROX. WEIGHT
2326	Brace & cover (10"H x 26"W)	10 lbs.
2350	Brace & cover (10"H x 50"W)	26 lbs.
2372	Brace & cover (10"H x 72"W)	35 lbs.
2348	Brace & cover for GL2248 corner	22 lbs.

NOTE: Two back panels and three braces are necessary to enclose back side of a 2001-DF or 2001-FF upright.

Advantage 2000+ Workstations

Four Point Solid Shelves

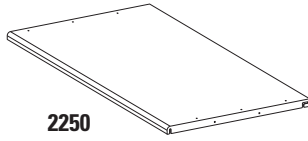

2250

PART NO.	THICKNESS	WIDTH	DEPTH	WEIGHT CAP.	APPROX. WEIGHT
2226	1.25"	25.75"	25.50"	600 lbs.	22 lbs.
2250	1.25"	49.75"	25.50"	600 lbs.	40 lbs.
2272	1.25"	71.75"	25.50"	500 lbs.	58 lbs.

Cantilevered Solid Shelves

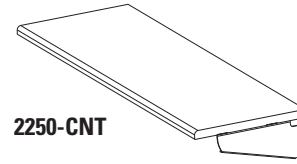

2250-CNT

PART NO.	THICKNESS	WIDTH	DEPTH	WEIGHT CAP.	APPROX. WEIGHT
2226-CNT	1.25"	25.875"	18.00"	600 lbs.	19 lbs.
2250-CNT	1.25"	49.875"	18.00"	500 lbs.	32 lbs.
2272-CNT	1.25"	71.875"	18.00"	400 lbs.	45 lbs.

Four Point Slotted Accessory Tilt Shelves

**FOUR POINT SLOTTED ACCESSORY SHELVES
TILT +/- 15 DEGREES (13 DIFFERENT POSITIONS)**

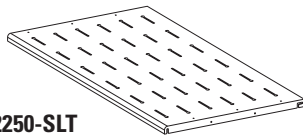

2250-SLT

PART NO.	THICKNESS	WIDTH	DEPTH	WEIGHT CAP.	APPROX. WEIGHT
2226-SLT	1.25"	25.75"	25.50"	600 lbs.	21 lbs.
2250-SLT	1.25"	49.75"	25.50"	600 lbs.	40 lbs.
2272-SLT	1.25"	71.75"	25.50"	500 lbs.	57 lbs.

Cantilevered Slotted Accessory Shelves

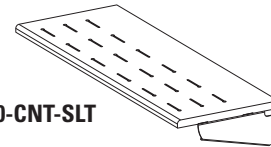

2250-CNT-SLT

PART NO.	THICKNESS	WIDTH	DEPTH	WEIGHT CAP.	APPROX. WEIGHT
2226-CNT-SLT	1.25"	25.875"	18.00"	600 lbs.	19 lbs.
2250-CNT-SLT	1.25"	49.875"	18.00"	500 lbs.	32 lbs.
2272-CNT-SLT	1.25"	71.875"	18.00"	400 lbs.	44 lbs.

Four Point Laminated Work Surfaces

**LAMINATED WORK SURFACE REINFORCED WITH STEEL
ACCESSORY MOUNTING UNDERPLATE**

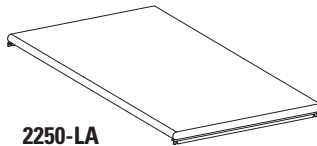

2250-LA

PART NO.	THICKNESS	WIDTH	DEPTH	WEIGHT CAP.	APPROX. WEIGHT
2226-LA	1.25"	25.75"	25.50"	400 lbs.	32 lbs.
2250-LA	1.25"	49.75"	25.50"	300 lbs.	55 lbs.
2272-LA	1.25"	71.75"	25.50"	200 lbs.	78 lbs.

NOTE: Laminate color - White Nebula

Laminated Countertop Extension

**LAMINATED WORK SURFACE REINFORCED WITH STEEL
ACCESSORY MOUNTING UNDERPLATE**

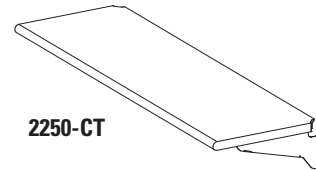

2250-CT

PART NO.	THICKNESS	WIDTH	DEPTH	WEIGHT CAP.	APPROX. WEIGHT
2226-CT	1.25"	28.00"	16.00"	400 lbs.	23 lbs.
2250-CT	1.25"	52.00"	16.00"	300 lbs.	43 lbs.
2272-CT	1.25"	74.00"	16.00"	200 lbs.	63 lbs.

NOTE: Laminate color - White Nebula

Four Point Deep Laminated Work Surfaces

**LAMINATED WORK SURFACE REINFORCED WITH STEEL
ACCESSORY MOUNTING UNDERPLATE**

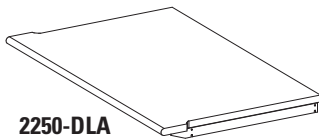

2250-DLA

PART NO.	THICKNESS	WIDTH	DEPTH	WEIGHT CAP.	APPROX. WEIGHT
2226-DLA	1.25"	25.75"	31.56"	600 lbs.	40 lbs.
2250-DLA	1.25"	49.75"	31.56"	600 lbs.	72 lbs.
2272-DLA	1.25"	71.75"	31.56"	500 lbs.	102 lbs.

NOTE: Laminate color - White Nebula



Advantage 2000+ Workstations

Keyboard Trays

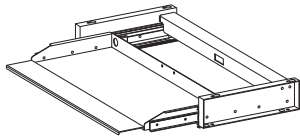

2535-KBSL

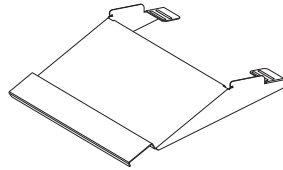

2535-KBSTA

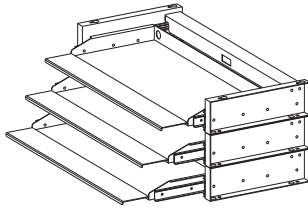

2535-KBAM

PART NO.	DESCRIPTION	APPROX. WEIGHT
2535-KBSL	Stackable sliding keyboard tray w/wrist rest (20.50"W x 8.375"D)	12 lbs.
2535-KBSTA	Stationary keyboard tray w/wrist rest (20.50"W x 8.375"D) adjustable left to right	7 lbs.
2535-KBAM	Articulated sliding keyboard tray (20.00"W x 8.75"D) w/wrist rest and mouse tray	18 lbs.

Drawers

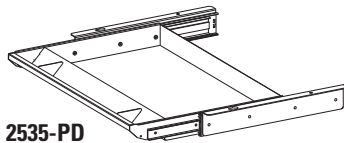

2535-PD

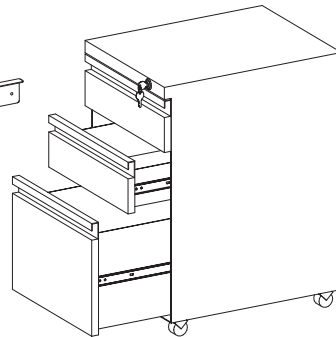

2565

PART NO.	DESCRIPTION	APPROX. WEIGHT
2535-PD	Pencil drawer (20.75"W x 15.00"D)	13 lbs.
2565	Lockable three drawer unit on casters (26.25"H x 15.00"W x 19.50"D)	66 lbs.

Lockable Overhead Storage Compartments

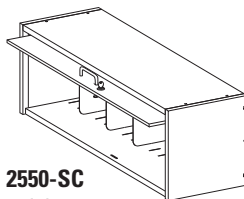

2550-SC
w/Four (4) dividers

PART NO.	HEIGHT	DEPTH	WIDTH	WEIGHT CAP.	APPROX. WEIGHT
2526-SC	16.00"	15.25"	26.00"	225 lbs.	51 lbs.
2550-SC	16.00"	15.25"	50.00"	200 lbs.	98 lbs.
2572-SC	16.00"	15.25"	72.00"	150 lbs.	141 lbs.

NOTE: 2526-SC has Two (2) dividers & 2572-SC has Six (6) dividers

Peninsula Work Surface w/ Adjustable Support Leg

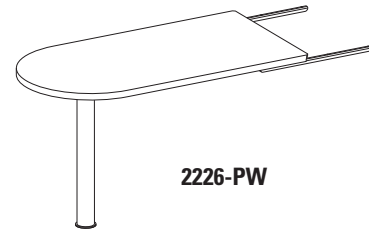

2226-PW

PART NO.	DESCRIPTION	APPROX. WEIGHT
2226-PW	Peninsula work surface assembly (24.63"W x 48.00"L), weight capacity 225 lbs.	100 lbs.
2226-PWC	Peninsula work surface with casters	100 lbs.

Inside Corner Shelves & Countertops



2248



2248-LA

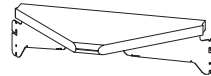

2248-CT



2248-CNT

PART NO.	DEPTH	WEIGHT CAP.	DESCRIPTION	APPROX. WEIGHT
2248	48.00"	300 lbs.	5 point corner shelf	50 lbs.
2248-LA	48.00"	300 lbs.	5 point laminated corner shelf	60 lbs.
2248-CT	12.25"	300 lbs.	Laminated countertop	20 lbs.
2248-CNT	18.00"	300 lbs.	Cantilevered laminated corner shelf	50 lbs.
2248-DLACT	N/A	N/A	DLA corner countertop extension (48" x 48" corner)	

NOTE: Laminate color - White Nebula

Floor Mount Sliding Double Wide Tower Shelves

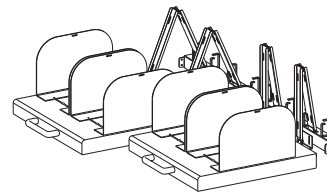

2250-TC2

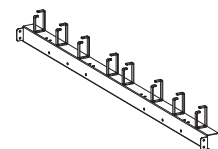

2250-TCBS

PART NO.	SHELF THICK.	SHELF W	SHELF D	WEIGHT CAP.	APPROX. WT.
2226-TC*	3"	23.50"	23.478"	775 lbs.	64 lbs.
2226-TC1	3"	23.50"	23.478"	775 lbs.	64 lbs.
2226-TCBS	Back Stop for TC Shelf w/Cable Management				
2250-TC1	3"	23.50"	23.478"	775 lbs./shelf	68 lbs.
2250-TC2	3"	23.50"	23.478"	775 lbs./shelf	196 lbs.
2250-TCBS	Back Stop for TC Shelf w/Cable Management				
2272-TC1	3"	23.50"	23.478"	775 lbs./shelf	70 lbs.
2272-TC2	3"	23.50"	23.478"	775 lbs./shelf	134 lbs.
2272-TC3	3"	23.50"	23.478"	775 lbs./shelf	198 lbs.
2272-TCBS	Back Stop for TC Shelf w/Cable Management				

*Double Wide Tower Shelf only, backstop required

NOTE: All TC series shelves mount to uprights with leveling glides only

Advantage 2000+ Workstations

Horizontal Cable Management Tray

- FEATURES:**
- Front access to Cable Management
 - Power strips can be mounted in Cable Management Tray
 - Mounts to all four point shelves
 - Mounts to all cantilevered shelves except LT (Light Duty)

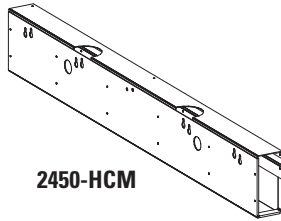

2450-HCM

PART NO.	WIDTH	DESCRIPTION	APPROX. WEIGHT
2426-HCM	19.75"	Horizontal cable mgmnt. tray	6 lbs.
2450-HCM	43.75"	Horizontal cable mgmnt. tray	12 lbs.
2472-HCM	65.75"	Horizontal cable mgmnt. tray	18 lbs.
2448-HCM	35.125"	Horizontal cable mgmnt. tray	12 lbs.

NOTE: Cable trough is 2.25"W x 5.50"D

VCM Vertical Cable Management



2400-VCM



2400-VCMHL



2400-VCMHR

PART NO.	LENGTH	DESCRIPTION	APPROX. WEIGHT
2400-VCM	22.00"	VCM for full frame or "d" frame upright	1 lb.
2400-VCMHL	21.12"	VCM for half ht. frame left hand side	1 lb.
2400-VCMHR	21.12"	VCM for half ht. frame right hand side	1 lb.

NOTE: 2001-DF and 2001-FF uprights will accept three (3) 2400-VCM for full height vertical cable management

Miscellaneous Accessories

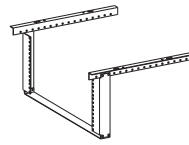

2520-19RK

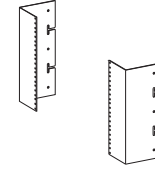

2526-19F

PART NO.	DESCRIPTION	APPROX. WEIGHT
2520-19RK	19" EIA spacing, 5U rack spaces, 8.75"H for four point and cantilevered shelves, except light duty cantilevered shelf	10 lbs.
2526-19F	19" EIA spacing, 7U rack spaces, 12.25"H for 26" wide configurations	10 lbs.

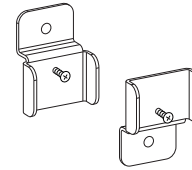

2540-PSB

PART NO.	DESCRIPTION	APPROX. WEIGHT
2540-PSB	Vertical power strip mounting bracket, one pair.	



PART NO.	DESCRIPTION	APPROX. WEIGHT
2508	Two (2) casters -locking	1 lb.

*** Caution:** Casters have to be completely threaded in and seated against the bottom of the frame to prevent damage to receiving nut and frame during workstation rolling.

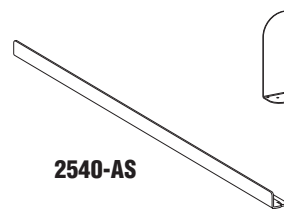

2540-AS

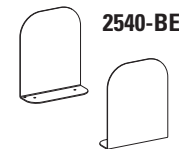

2540-BE

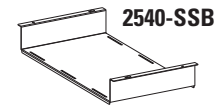

2540-SSB

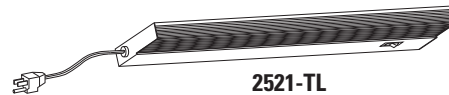

2521-TL

PART NO.	DESCRIPTION	APPROX. WEIGHT
2540-AS	Anti-slide bracket for slotted tilt shelves	1 lb.
2540-BE	Book ends for slotted tilt shelves, 6"D x 7.50"H, one pair	1 lb.
2540-SSB	Stationary switch box shelf (21.75"W x 12"D x 2.75"H)	8 lbs.
2521-TL	Low profile task light (22" W x 5"D x 1"H), magnetically mounted	10 lbs.